

London PP



GRAFU
SINCE 1997



London PP



Comfort

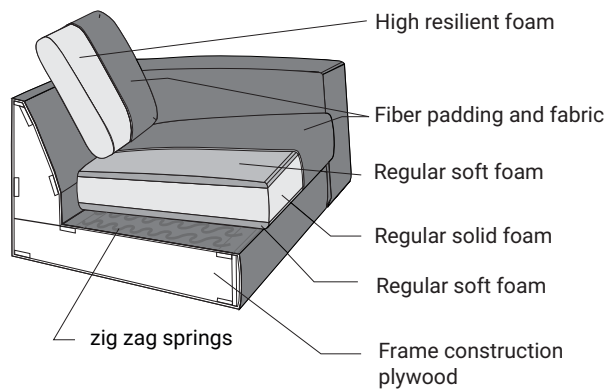

Extra dimensions

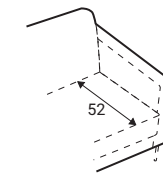

depth of seat

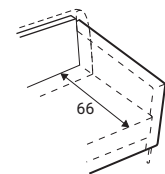

depth of seat without back cushions

Legs



Leg M03 H-100
Metal, chrome



Leg M04 H-100
Metal, black



Leg W25 H-90
Solid wood, painted black

- All further product dimensions are indicated with 100mm legs.

Accessories

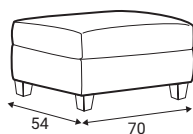

Footstool F7

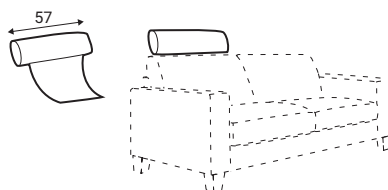

Neckrest

GRAFU reserves the right to change construction of products and components used due to improving durability of product and customer satisfaction without any further notice. Upholstered furniture is handmade using soft materials therefore measurements may vary up to +/- 3cm. Slight colour variations may occur between production batches. For technological reasons variations in color shades are acceptable.



London PP



Standard sets

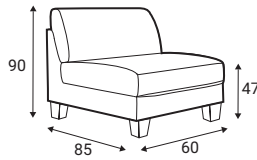

60 - middle part

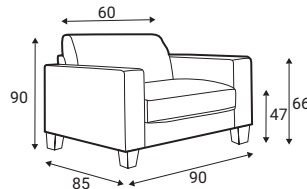

1S - seater

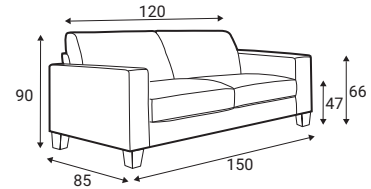

2S - seater

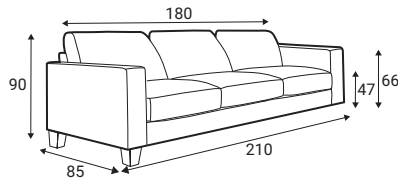

3S - seater

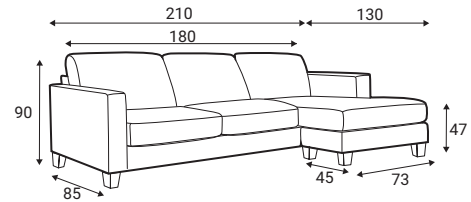

1 - universal

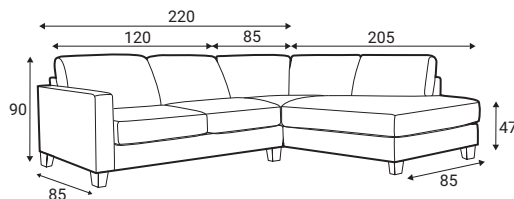

2R - right

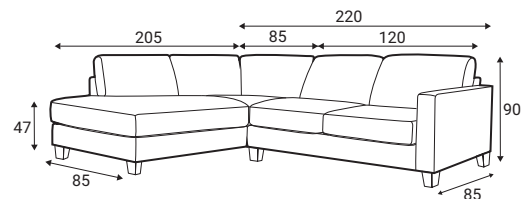

2L - left

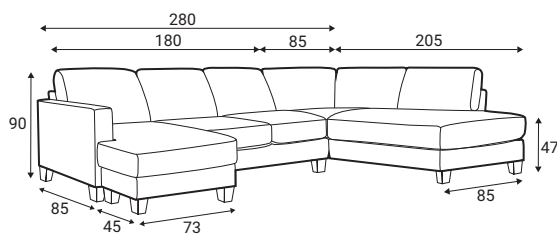

3R - right

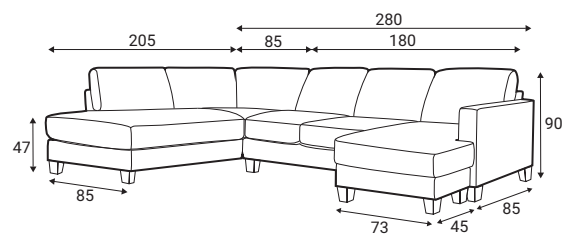

3L - left

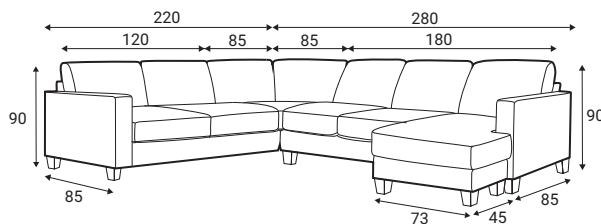

4R - right

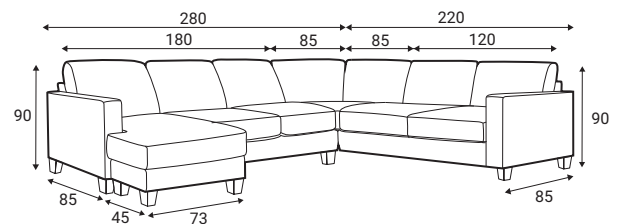

4L - left

GRAFU reserves the right to change construction of products and components used due to improving durability of product and customer satisfaction without any further notice. Upholstered furniture is handmade using soft materials therefore measurements may vary up to +/- 3cm. Slight colour variations may occur between production batches. For technological reasons variations in color shades are acceptable.



London PP



Standard sets

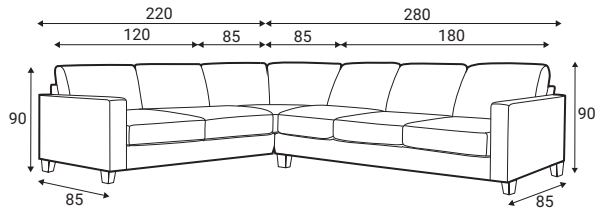

5R - right

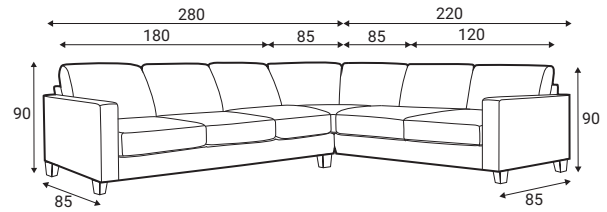

5L - left

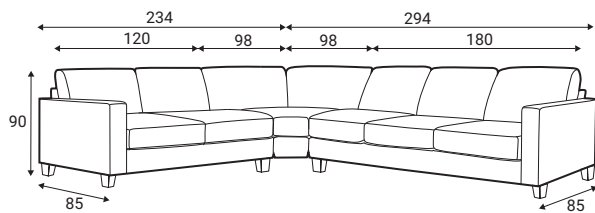

C5R - right

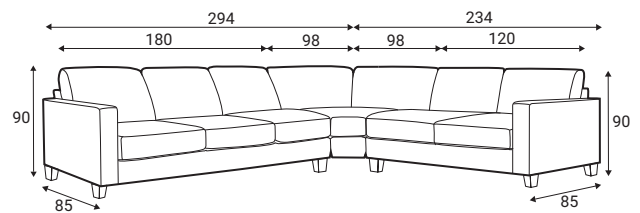

C5L - left

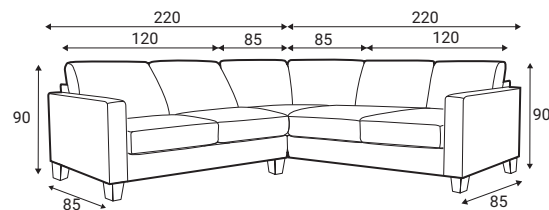

7 - symmetrical

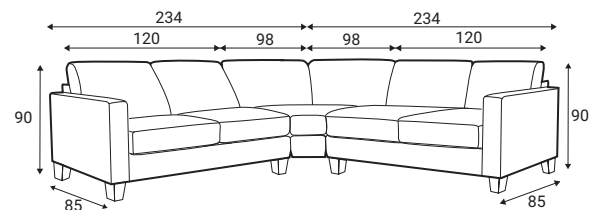

C7 - symmetrical

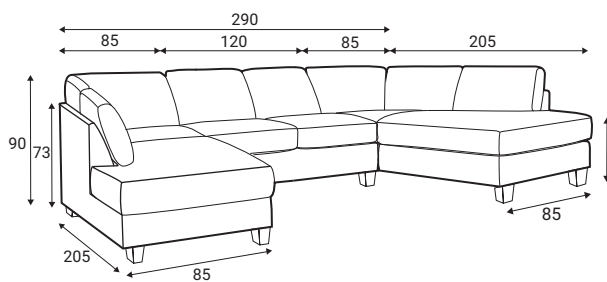

8 - symmetrical

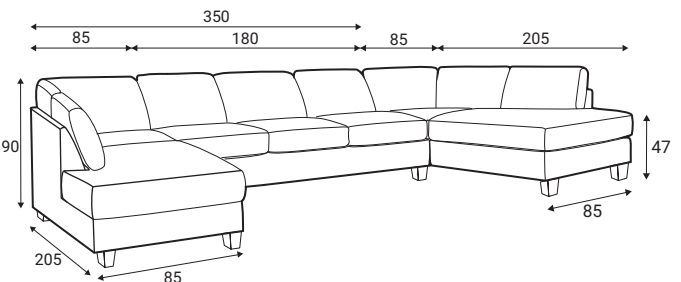

83 - symmetrical

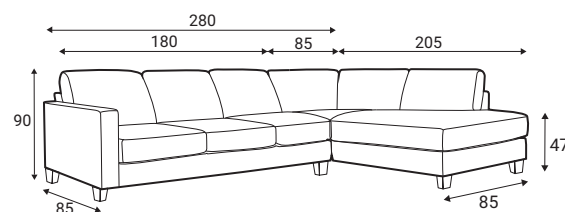

11R - right

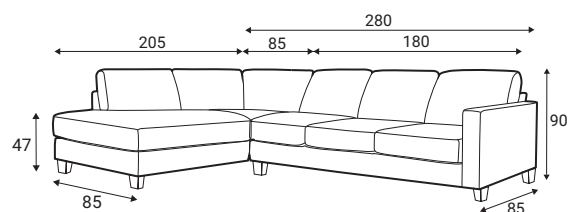

11L - left

GRAFU reserves the right to change construction of products and components used due to improving durability of product and customer satisfaction without any further notice. Upholstered furniture is handmade using soft materials therefore measurements may vary up to +/- 3cm. Slight colour variations may occur between production batches. For technological reasons variations in color shades are acceptable.



London PP



Standard sets

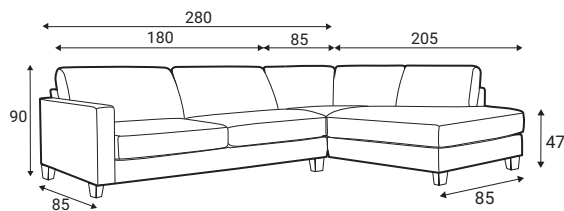

101R(90) - right

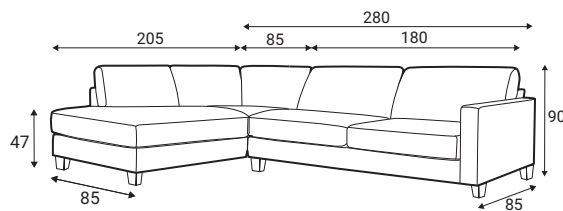

101L(90) - left

Furniture features in symbols



- Seat and back cushions are loose from the frame.



- Fabric



- Removable cover for loose cushions.
(For maintenance please check fabric information.)

GRAFU reserves the right to change construction of products and components used due to improving durability of product and customer satisfaction without any further notice. Upholstered furniture is handmade using soft materials therefore measurements may vary up to +/- 3cm. Slight colour variations may occur between production batches. For technological reasons variations in color shades are acceptable.