

Zoom



GRAFU
SINCE 1997



Zoom



Comfort

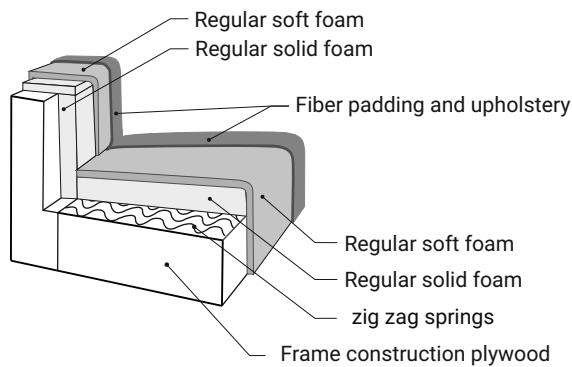

French seam (20mm) on back cushions

Extra dimensions

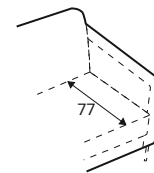

depth of seat

Legs



Foot P02, H-40
Black

Decorative pillows

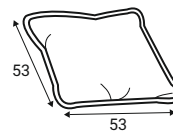

Pillow D1 EV

• EV pillows with 2cm FR seam

Armrests

A30xH65



A30HxH50



A33xH50



GRAFU reserves the right to change construction of products and components used due to improving durability of product and customer satisfaction without any further notice. Upholstered furniture is handmade using soft materials there fore measurements may vary up to +/- 3cm. Slight colour variations may occur between production batches. For technological reasons variations in color shades are acceptable.



Modules Dimensions with A30xH65 armrest

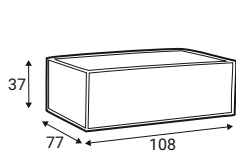

Footstool

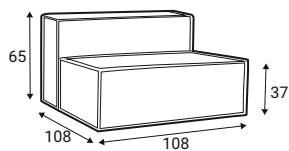

105 - middle part

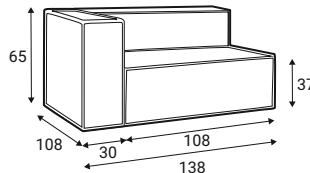

105L - left

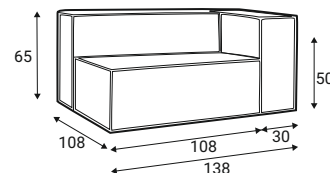

105R - right

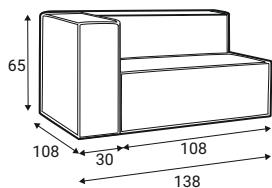

C1L - corner part, left

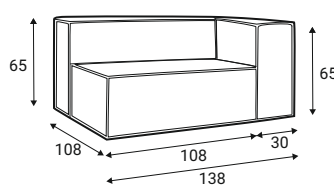

C1R - corner part, right

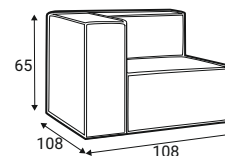

C1 - corner part

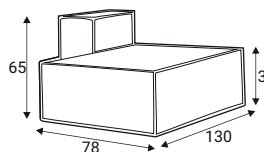

OEL
open end left

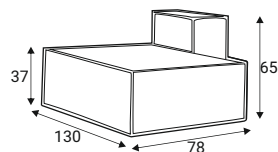

OER
open end right

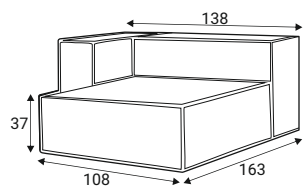

D105L
chaiselongue left

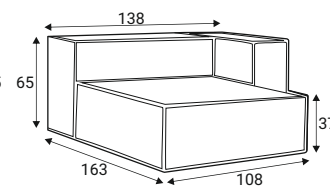

D105R
chaiselongue right

Modules Dimensions with A33xH50 armrest

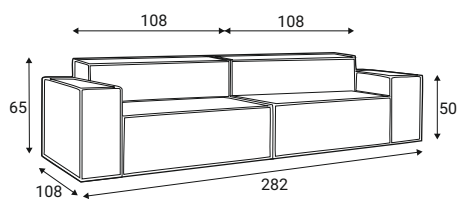

105L+105R

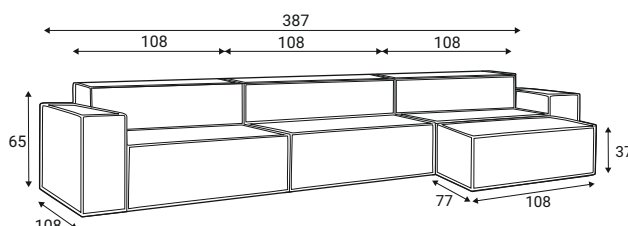

105L+105+105R+Footstool

Furniture features in symbols



- Seat and back cushions are fixed to the frame.



- Fabric



- Removable cover for loose cushions.
(For maintenance please check fabric information.)



- Modular system

GRAFU reserves the right to change construction of products and components used due to improving durability of product and customer satisfaction without any further notice. Upholstered furniture is handmade using soft materials there fore measurements may vary up to +/- 3cm. Slight colour variations may occur between production batches. For technological reasons variations in color shades are acceptable.